

OptiLine Louvre Extra wide

35.306 · Pitch dependent louvre optics

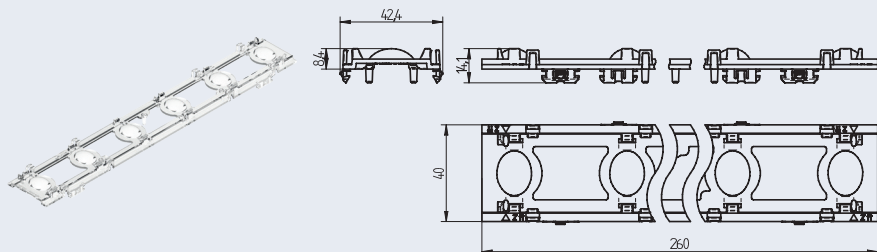

pkg. wt. part no.
96 23.2 g 35.306.1003.85

1-Click Louvre optics

1R linear single lens optics

The 35.306 (1ft) optics are designed for use with 35.306.2001 (louvre 1 ft) and 35.312.2001 (louvre 2ft).

Optics and louvre are only available separately.

1-Click push-in fixing into metal sheet or aluminium profile

For metal sheets: 0.5 - 1.0 mm

Material: PC

Light distribution: Medium

- **Homogeneous color mixing (also with tunable white applications)**

Technical details

- Push-in fixing into metal sheet or aluminium profile
 - Centering pins for optimal alignment of optics and LED module
 - Snap-in hooks for fixing LED module and optics in one step
 - Integrated cable holders for wire management
 - 2 cables per cable holder possible
 - Centering pins for alignment and snap-in hooks for fixing the louvre
- [See page 3 and 4 for more information on the louvre]

Area of application:

Applications that require optimal light and minimal glare

Height	13 mm
Width	40 mm
Length	260 mm
Type of fixing	Push-in fixing into metal sheet or aluminium profile
LED Type	Philips Fortimo LED-R
Pitch distance	46.67 mm
Material	PC
Colour	clear
Surface outside	Single lens optics
Lichtverteilung	Extra wide
Optical efficiency (louvre black)	85 %
Optical efficiency (louvre white)	95 %
UGR @ 1000 lm, 1 Fuß (crosswise)	≤ 21 (louvre black)
UGR @ 1000 lm, 1 Fuß (crosswise)	≤ 21 (louvre white)
Operating temperature	max. 110 °C

The presented information are for reference only. All lighting parameters are typical values.
The light distribution depends on the used Type of LED, position tolerance, chip size and used colour.

Light distribution: black louvre

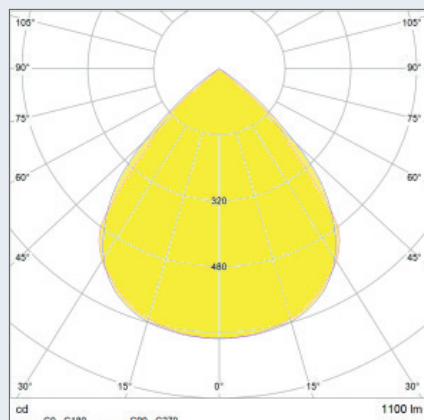

Light distribution: white louvre

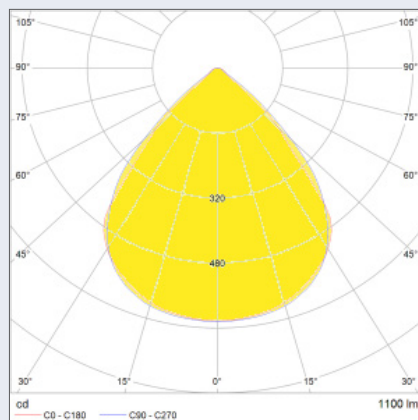

Louvre black

Light distribution: Extra wide
Efficiency: 85%

Louvre white.

Light distribution: Extra wide
Efficiency: 95%

measured with:
Philips Fortimo LED-R FT 1ft MF 927-965 FC HV5

OptiLine Louvre Extra Wide

35.306 · Pitch dependent louvre optics - Metal sheet cut-out and Aluminium profile

Metal sheet cut-out

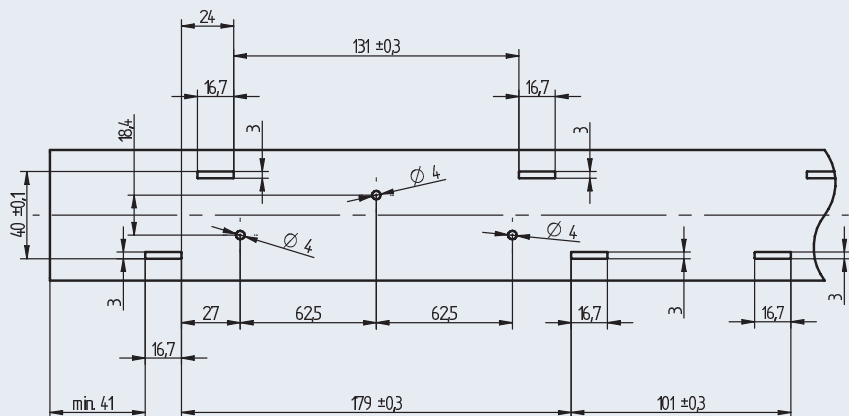

Aluminium profile

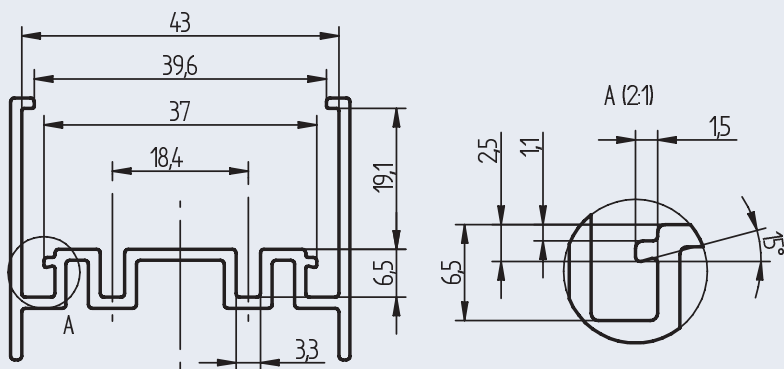

OptiLine Louvre Black / White

35.312 · Louvre 2ft

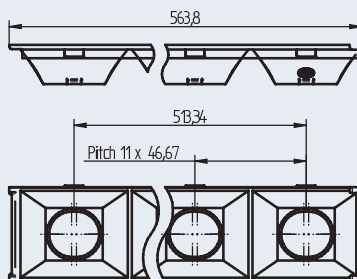
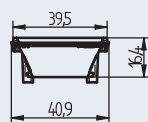
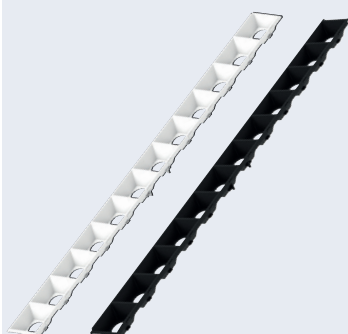

pkg.	wt.	part no.
144	64.2 g	35.312.2001.80 black
144	64.2 g	35.312.2001.50 white

Louvre 2ft

For use with 1R louvre optics

- 35.106.1001.85** Medium
- 35.106.1002.85** Wide
- 35.106.1003.85** Extra wide
- 35.106.1004.85** Single asymmetric
- 35.106.1005.85** Double asymmetric

Optics and louvre are only available separately

Snap-on fixing

Material: PC

Technical details

- Centering and positioning pins for aligning the louvre
- Snap-in hooks for fixing louvre into the optics
- Overlap at the louvre end
 - compensates thermal expansion
 - avoidance of stray light
- Seamless integration into the luminaire housing

Height	16.4 mm
Width	40.9 mm
Length	563.8 mm
Type of fixing	Snap into the optics
Pitch distance	46.67 mm
Material	PC
Colour	black or white
Operating temperature	max. 110 °C

Exploded view with metal sheet

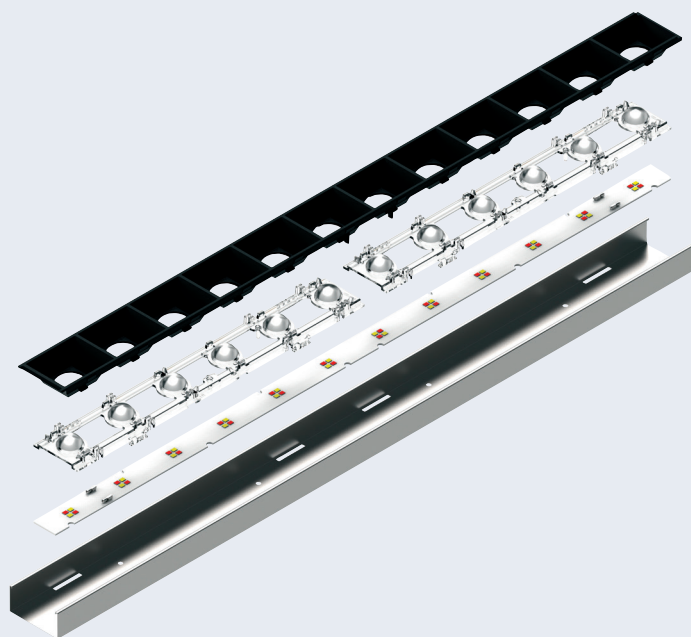

Exploded view with aluminium profile

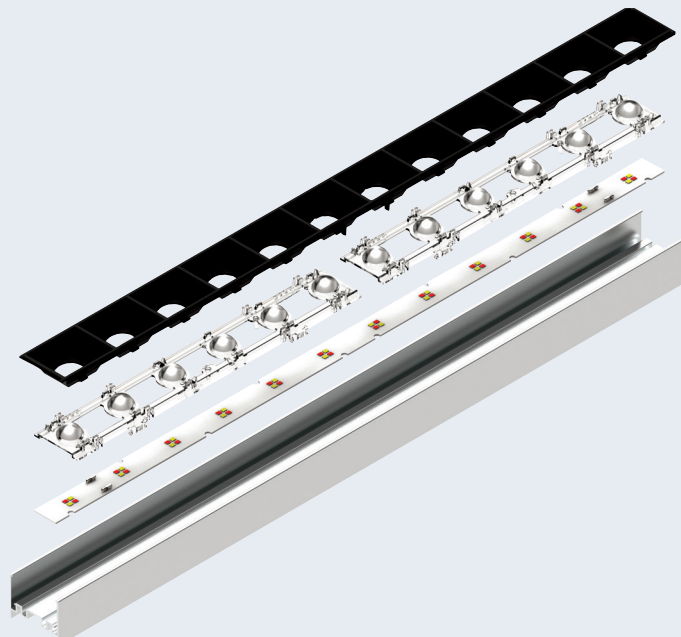

OptiLine Louvre Black / White

35.306 · Louvre 1 ft

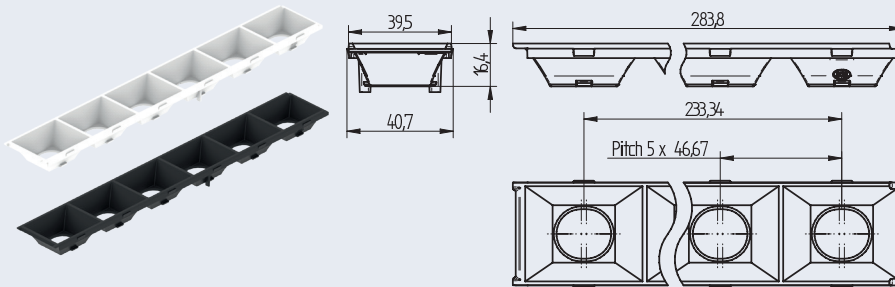

pkg.	wt.	part no
72	32.3 g	35.306.2001.80 black
72	32.3 g	35.306.2001.50 white

Louvre 1ft

For use with 1R louvre optics

35.106.1001.85 Medium

35.106.1002.85 Wide

35.106.1003.85 Extra wide

35.106.1004.85 Single asymmetric

35.106.1005.85 Double asymmetric

Optics and louvre are only available separately

Snap-on fixing

Material: PC

Technical details

- Centering and positioning pins for aligning the louvre
- Snap-in hooks for fixing louvre into the optics
- Overlap at the louvre end
 - compensates thermal expansion
 - avoidance of stray light
- Seamless integration into the luminaire housing

Height	16.4 mm
Width	40.7 mm
Length	283.8 mm
Type of fixing	Snap into the optics
Pitch distance	46.67 mm
Material	PC
Colour	black or white
Operating temperature	max. 110 °C

Exploded view with metal sheet

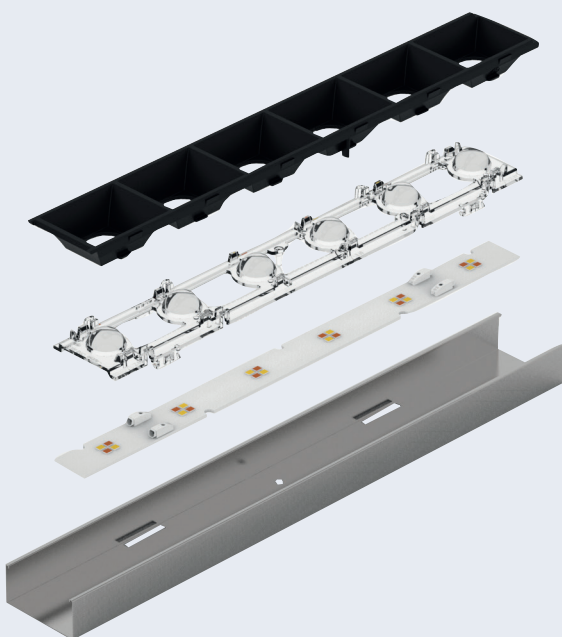

Exploded view with aluminium profile

