

Terminal Block 5 poles

46.456 Terminal Block 5 poles

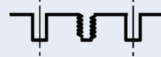
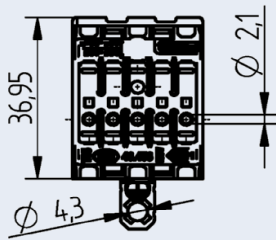
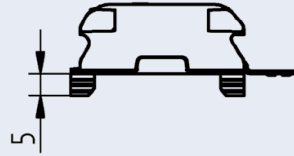
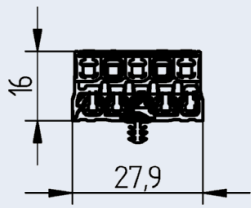

Alustrangpressprofil mit M4 Gewindekanal /
Aluminum extrusion with M4 threaded channel

Part no.
46.456.1012-0

Marking:
No. of poles
Mechanical fixation
PE contact

L - N - ES - DA+ - DA- *
5
Pin for profile groove
Earthing bracket
*ES = Earth symbol

- New family of RAST5 Terminal Blocks with 16mm height, a perfect fit to all standard ECGs
- Wire release function on both sides for top connection
- Easy to use by push wire contacts
- Stranded wires on top connection possible
- Multiple earthing possibilities: earthing bracket, rapid earth contact and earthing sign
- Different mechanical fixation methods: snap-in pins, pin for aluminum profiles and screw mounting
- Different standard markings available, more on demand

Electrical data	
Ratings accordint to (pending)	EN IEC 60998-1 EN IEC 60998-2-2
Rated voltage	450 V
Rated impulse voltage	2,5 KV
Rated current	24 A
Rated connection capacity	2,5 mm ² / 24A
Rated connection capacity	1,5 mm ² / 17,5A
Rated connection capacity	1,0 mm ² / 13,5A
Rated connection capacity	0,75 mm ² / 9A
Rated connection capacity	0,5 mm ² / 6A
Degree of pollution	2
Overvoltage category	II
Connection data	
Connection type 1	External, top
Connection technology	Push wire contact
Actuation type	Push-button
No. of connection points	1
Wire material	Copper
Solid wires	0.5 - 2.5 mm ²
Solid wires; Directly pluggable	0.5 - 2.5 mm ²
Stranded wire	1,5 ... 2,5 mm ²
Solid wires; Directly pluggable	0.5 - 2.5 mm ²
Fine stranded wire	1,5 ... 2,5 mm ²
Strip length 0.5 - 1,0 mm ²	9 ... 10 mm / 0,354 ...0,393 inch
Connection type 2	External, bottom
Connection technology	Push wire contact
No. of connection points	1
Actuation type	Axial release pin 1,2mm
Wire material	cooper
Solid wires	0,5 ... 2,5 mm ²
Solid wires; Directly pluggable	0,5 ... 2,5 mm ²
Stranded wire	1,5 ... 2,5 mm ²
Strip length 0.5 - 1,0 mm ²	9 ... 10 mm / 0,354 ...0,393 inch

Connection data	
Connection type 3	Internal, top
Connection technology	Push wire contact
No. of connection points	1
Actuation type	Push-button
Solid wires	0,5 ... 2,5 mm ²
Solid wires; Directly pluggable	0,5 ... 2,5 mm ²
Stranded wire	1,5 ... 2,5 mm ²
Fine stranded wire	1,5 ... 2,5 mm ²
Strip length 0.5 - 1,0 mm ²	9 ... 10 mm / 0,354 ...0,393 inch
Connection type 4	Internal, bottom
Connection technology	Push wire contact
No. of connection points	1
Actuation type	Axial release pin 1,2mm
Solid wires	0,5 ... 2,5 mm ²
Solid wires; Directly pluggable	0,5 ... 2,5 mm ²
Stranded wire	1,5 ... 2,5 mm ²
Strip length 0.5 - 1,0 mm ²	9 ... 10 mm / 0,354 ...0,393 inch
Material data	
Color	White
Insulating material group	III a
Insulating material	Polycarbonat (PC)
Flammability class per UL94	V-2
Clamping spring material	Chrome nickel spring steel (CrNi)
Contact material	Electrolytic copper (E _{cu})
Contact surface	Tin-plated
Geometric data	
Raster dimension	5 mm / 0.196 inch
Width	28 mm / 1.102 inch
Height from the surface	16 mm / 0.630 inch
Depth	37 mm / 1.456 inch
Environmental conditions	
Temperature resistance	Permissible ambient temperature: -40 °C to 85 °C (at maximum test current of 24 A)
T-marking	T85
Packaging data	
Product weight	TBD g
Packaging	500 pcs. / carton

Terminal Block 5 poles

46.456 Terminal Block 5 poles

external wiring
(installation)

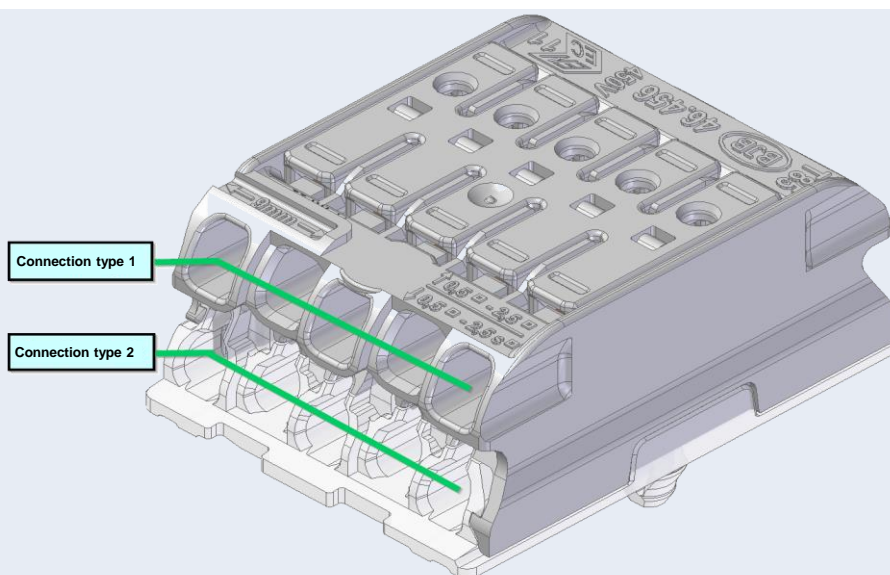

internal wiring
(luminaire)

